



HOSHIZAKI

- > **IM-240NE**
- > **IM-240NE-21**
- > **IM-240NE-23**

Daily ice production capacity up to **240KG**



Cube ice is perfectly symmetrical and leaves a good impression with its hard, crystal clear quality that melts very slowly; allowing customers to enjoy their favourite drink longer, The IM series allows more flexibility of application with each range offering ice in variable sizes alongside a design for uncomplicated usage from start to finish.



CUBE ICE MAKER SERIES

FEATURES

- > smart computer board technology
- > slide-in air filter for easy cleaning
- > LED error indicator for easy diagnosis
- > stainless steel exterior provides a hygienic and high quality finish



UNIQUE ICE PRODUCTION SYSTEM

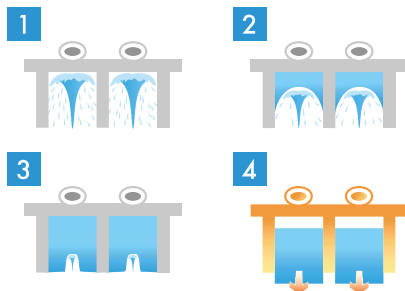

- > Individual cube
- > Impurity free
- > Hardest ice to enjoy slow melting and dilution of drinks

ICE SIZE

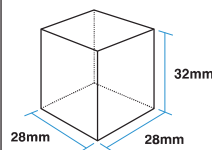

IM-240NE

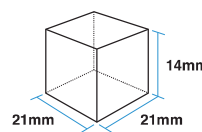

IM-240NE-21

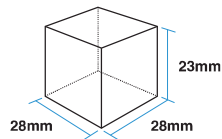

IM-240NE-23



DIMENSIONS & SPECIFICATION

CUBE ICE MAKER AIR SYSTEM

TOP SIDE

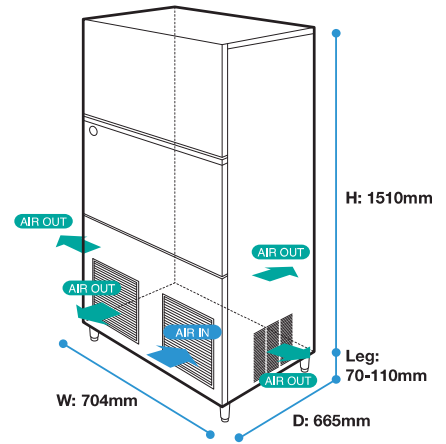
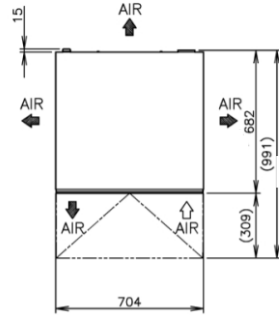

FRONT SIDE

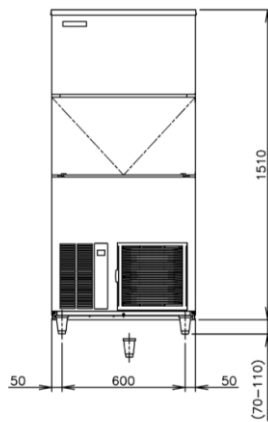

RIGHT SIDE

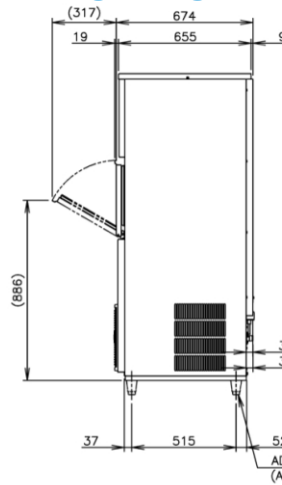

BACK SIDE

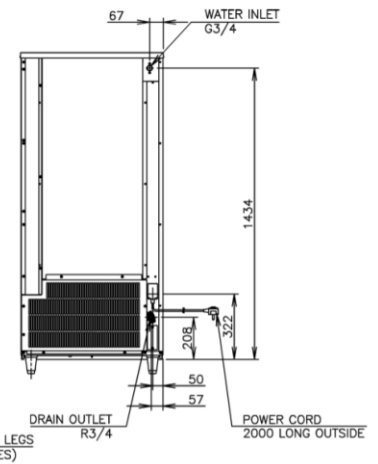

MODEL NAME		IM-240NE	IM-240NE-21	IM-240NE-23
ICE DIMENSIONS (MM) (W x D x H)		28 x 28 x 32	21 x 21 x 14	28 x 28 x 23
DIMENSIONS (MM) (W x D x H)		Body : 704 x 665 x 1510 / Leg Height : 70-110 mm		
PACKED DIMENSIONS (MM) (W x D x H)		805 x 760 x 1864	805 x 760 x 1864	805 x 760 x 1864
WEIGHT (NETT/GROSS)		111 KG / 128 KG	111 KG / 128 KG	111 KG / 128 KG
AMPERAGE / STARTING AMPERAGE		6.6A / 35A		
ELECTRICAL CONSUMPTION		1320 W		
REFRIGERANT CHARGE		R404a		
HEAT REJECTION (AT32°C/WT21°C)		2870 W (2470 kcal/h)		
ICE PRODUCTION PER 24H (15MM)	(AT10°C/WT10°C)	240 KG	217 KG (7mm)	225 KG
	(AT21°C/WT15°C)	230 KG	210 KG (7mm)	215 KG
	(AT32°C/WT21°C)	210 KG	190 KG (7mm)	195 KG
WATER CONSUMPTION PER 24H (AT32°C/WT21°C)		0.34 m ³	0.43 m ³	0.38 m ³
		1.62L / 1KG ICE	2.26L / 1KG ICE	1.95L / 1KG ICE
ICE PRODUCTION (AT32°C/WT21°C)	FREEZE CYCLE TIME	27 MIN	22 MIN	24 MIN
	PER CYCLE	3.2 KG / 140 PCS	2.1 KG / 360 PCS	2.38 KG / 140 PCS
STORAGE CAPACITY		110 KG		

• **WARRANTY:**
Two years parts & labour for entire unit, 3rd year on compressor only. Excluding door & exterior damages

• **OPERATING CONDITIONS:** • Voltage Range: 198V-254V • Ambient Temperature: 1°-40°C
• Water Supply: 5°-35°C / 0.07-0.8 Mpa / 7.25-116 PSI • AC Supply Voltage: 1/220-240V / 50 Hz
*60Hz units are available upon request

R1