



HOSHIZAKI



- > **B-301SA**
- > **B-501SA**
- > **B-801SA**

Storage bins are essential to ensure a continuous supply of ice, and these bins are made to fit Hoshizaki Ice Makers. Made of stainless steel, the bins are easy to clean.

FEATURES

- > Foamed-in-place insulation provides ice storage with a low melt rate.
- > Stainless steel exterior provides long lasting attractive appearance.
- > Easy to clean with rounded edges for optimum hygiene.
- > Sturdy side by side/stacked installation and non-corrosive bin liner provide safe and hygienic storage.

STORAGE CAPACITY

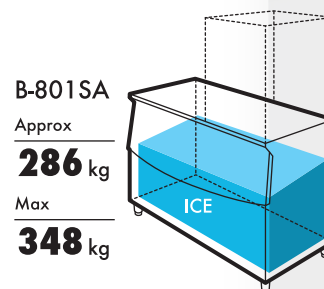
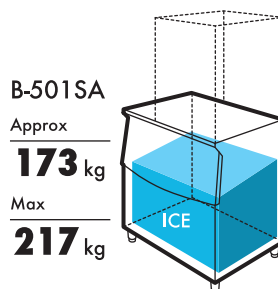
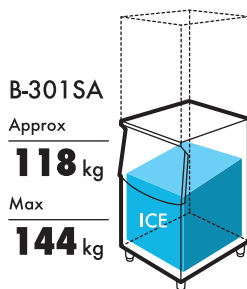

DIMENSIONS & SPECIFICATION

● B-301SA

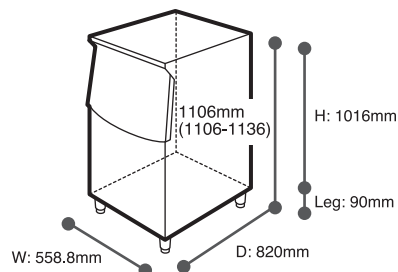

BACK VIEW

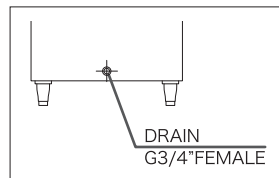

● B-501SA

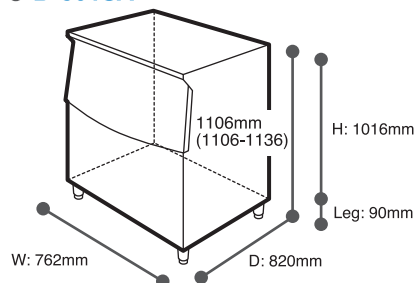

BACK VIEW

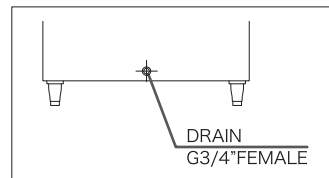

● B-801SA

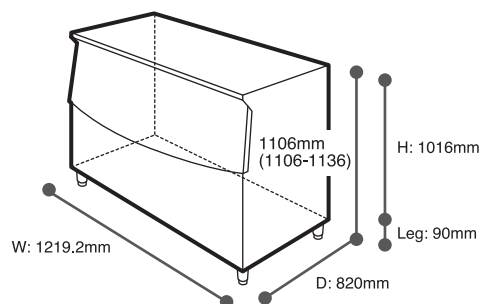

BACK VIEW

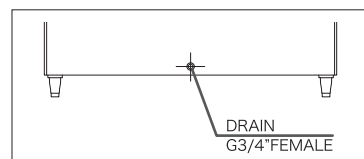

SPECIFICATION

MODEL NAME	B-301SA	B-501SA	B-801SA
STORAGE CAPACITY	Approx : 118kg / Max : 144kg	Approx : 173kg / Max : 217kg	Approx : 286kg / Max : 348kg
OUTSIDE DIMENSIONS(W x D x H)	558.8 x 820 x 1106(1106-1136)(mm)	762 x 820 x 1106(1106-1136)(mm)	1219.2 x 820 x 1106(1106-1136)(mm)
DOOR STYLE	Upward Opening	Upward Opening	Upward Opening
INSULATION	Polyurethane Foam	Polyurethane Foam	Polyurethane Foam
ACCESSORIES	Scoop , Leg (4 pcs)	Scoop , Leg (4 pcs)	Scoop , Leg (4 pcs)
WEIGHT (NET / GROSS)	37kg / 49kg	47kg / 62kg	64kg / 86kg

COMBINATION

Ice machine	FM-300 FM-480 IM-220AA KMD-201 KMD-270	KM-470AJ FM-750 FM-1000	FM-480x2	KMD201x2 KMD270x2 IM-220AAx2 FM-300x2 FM-480x2	KM-590DJ	IM-240DNE
Ice bin						
B-301SA						
Top Kit	No Top Kit					
B-501SA						
Top Kit	8D	No Top Kit				
B-801SA						
Top Kit	8D + 18D	18D	4DM	4DM+4DR	No Top Kit	IMD2